

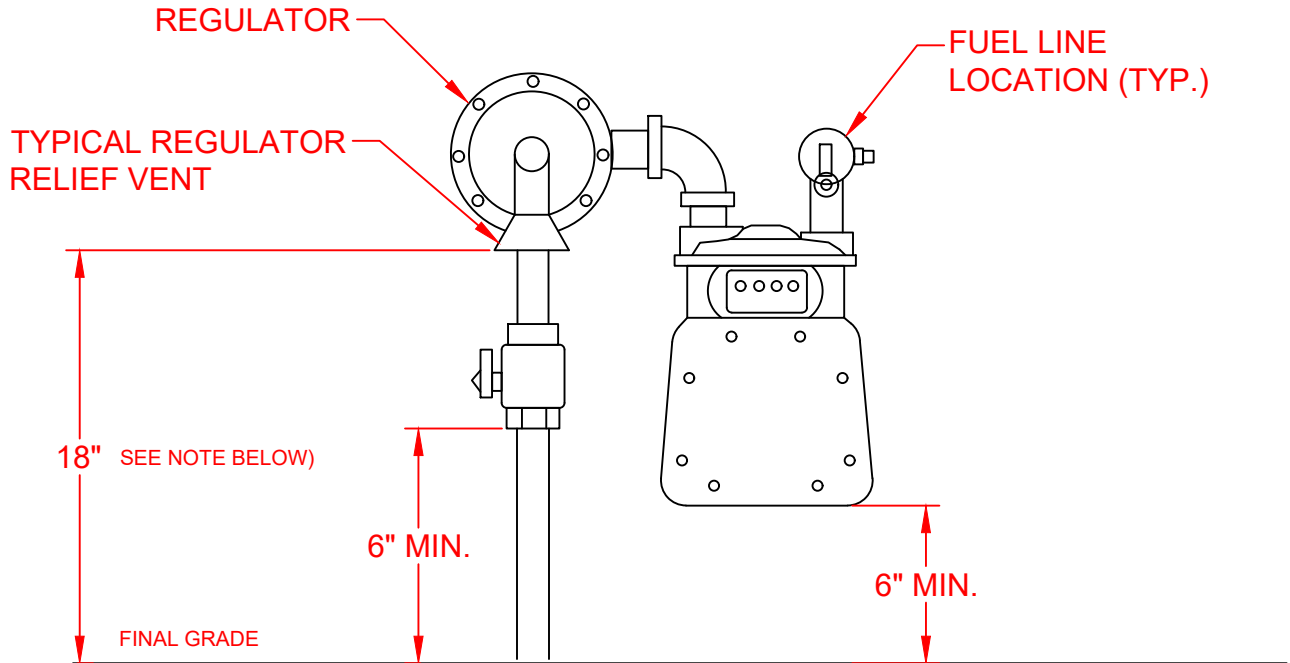

# DIAGRAM A

GAS METER CLEARANCES TO FINAL GRADE  
(250 METER SHOWN)



**NOTE:**

THE STANDARD INSTALLATION HEIGHT OF THE REGULATOR VENT IS APPROXIMATELY 28" FROM FINAL GRADE. HOWEVER, IF LOCAL CONDITIONS PREVENT THE STANDARD INSTALLATION, THE HEIGHT, WITH PRIOR SUPERVISORY APPROVAL, CAN BE REDUCED FOR THE INSTALLATION. UNDER NO CIRCUMSTANCES CAN THE HEIGHT BE REDUCED TO LESS THAN 18"

						DRAWN		 UNITIL GAS STANDARDS (NH & MA) GAS METER SET ASSEMBLIES INSTALLATION REQUIREMENTS			
						JNM					
						CHECKED CL					
						APPROVED		SCALE	DATE	SHEET	DRAWING NO.
REVISIONS						CL		N/A	4/3/12	1 OF 6	UAYMX001

# DIAGRAM B

## MEASURING AROUND A BUILDING CORNER REGULATOR CLEARANCE

### OUTSIDE CORNERS:

- CLEARANCE DISTANCES FROM THE REGULATOR RELIEF VENT OR METER SET ASSEMBLY TO THE FEATURE(S) MUST BE MAINTAINED IN ACCORDANCE WITH THE APPLICABLE IGNITION SOURCE/OPENING FEATURE CLEARANCE REQUIREMENT DIAGRAM. *MEASURE AS IF USING A STRING.*

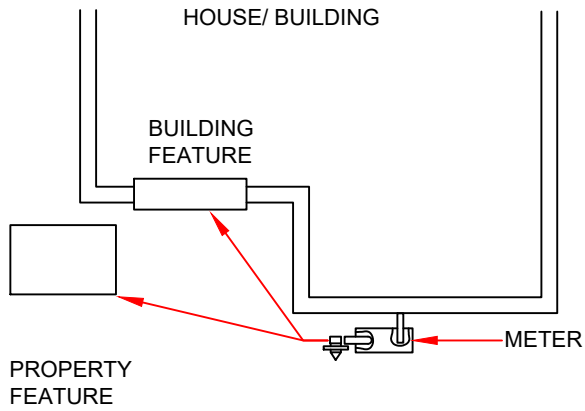

PLAN VIEW

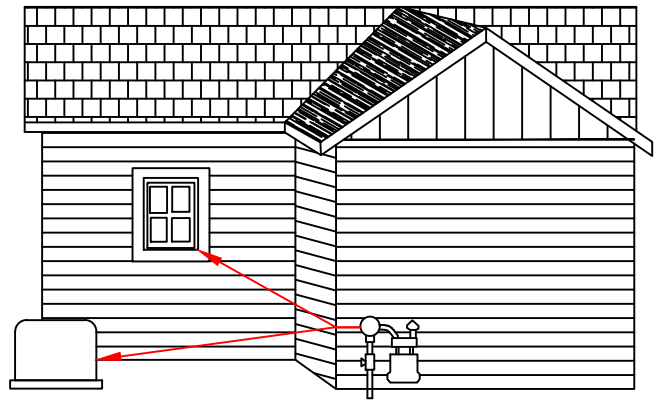

ELEVATION VIEW

						DRAWN						UNITIL GAS STANDARDS (NH & MA)							
						JNM						GAS METER SET ASSEMBLIES							
						CHECKED						INSTALLATION REQUIREMENTS							
						CL		APPROVED		SCALE		DATE		SHEET		DRAWING NO.			
A						REVISED NOTATION		JEH		10/07/22		N/A		4/3/12		2 OF 6		UAYMX001	
REV.						DESCRIPTION		BY		DATE		CHK		APR					
						REVISIONS		CL											

# DIAGRAM C

## MEASURING AROUND A BUILDING CORNER REGULATOR CLEARANCE

### INSIDE CORNERS:

- CLEARANCE DISTANCES FROM THE REGULATOR RELIEF VENT OR METER SET ASSEMBLY TO THE FEATURE(S) MUST BE MAINTAINED IN ACCORDANCE WITH THE APPLICABLE IGNITION SOURCE/OPENING FEATURE CLEARANCE REQUIREMENT DIAGRAM. *MEASURE AS IF USING A STRING.*

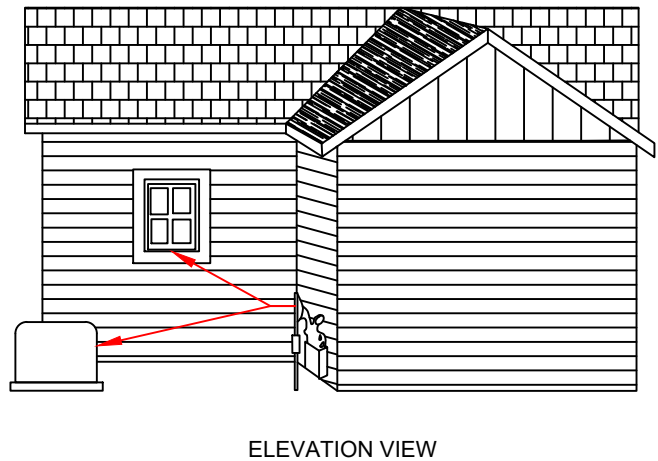
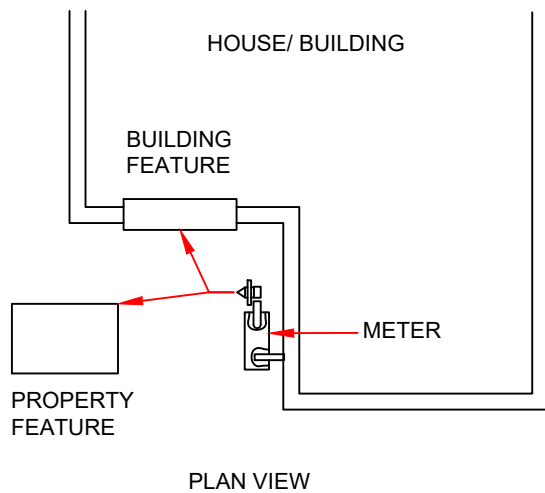

						DRAWN		 UNITIL GAS STANDARDS (NH & MA) GAS METER SET ASSEMBLIES INSTALLATION REQUIREMENTS							
						JNM									
						CHECKED									
						CL		SCALE							
						APPROVED		N/A		DATE		SHEET		DRAWING NO.	
						CL		4/3/12		3 OF 6		UAYMX001			
REVISIONS															
A	REVISED NOTATION	JEH	10/07/22												
REV.	DESCRIPTION	BY	DATE	CHK	APR										

# DIAGRAM D

## REGULATOR RELIEF VENT CLEARANCES FROM FEATURES

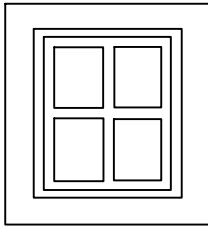

WINDOW OPENING

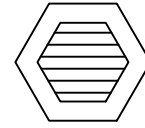

ATTIC VENT OPENING

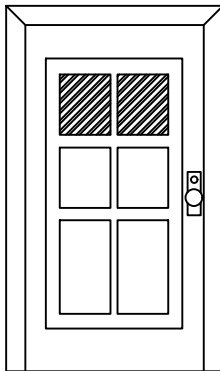

DOORS

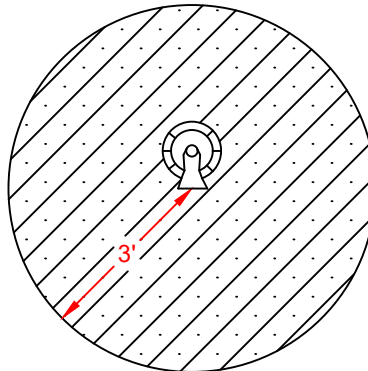

NO FEATURES TO BE PLACED WITHIN TOLERANCE ZONE (CROSS-HATCHED AREA)

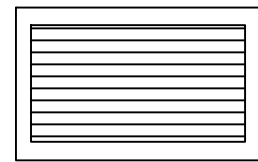

AIR INTAKE OPENING

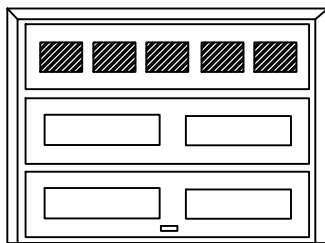

GARAGE DOORS



CRAWL SPACE OR GARAGE VENT OPENING

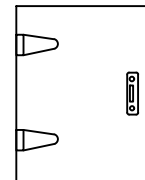

FIREPLACE CLEANOUT OPENING

REV.	DESCRIPTION	BY	DATE	CHK	APR
REVISIONS					

DRAWN	JNM
CHECKED	CL
APPROVED	CL



UNITIL GAS STANDARDS (NH & MA) GAS METER SET ASSEMBLIES OPENING FEATURES			
SCALE	DATE	SHEET	DRAWING NO.
N/A	11/03/22	4 OF 6	UAYMX001

# DIAGRAM E

## REGULATOR RELIEF VENT CLEARANCES FROM FEATURES

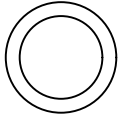

APPLIANCE COMBUSTION  
AIR INTAKE VENT OPENING

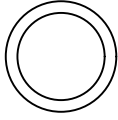

APPLIANCE EXHAUST  
VENT OPENING

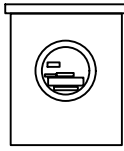

ELECTRIC METER

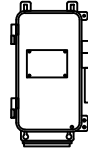

DISCONNECT

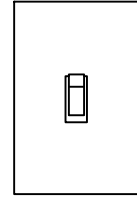

WALL SWITCH

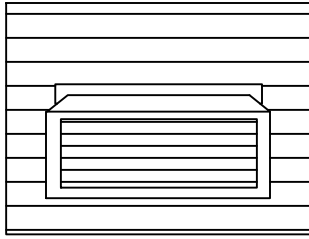

WALL MOUNTED  
AIR CONDITIONER

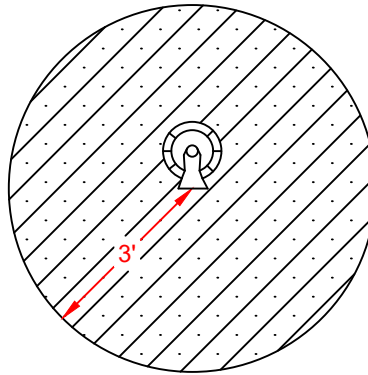

NO FEATURES TO BE PLACED  
WITHIN TOLERANCE ZONE  
(CROSS-HATCHED AREA)

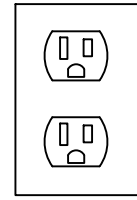

ELECTRIC OUTLET

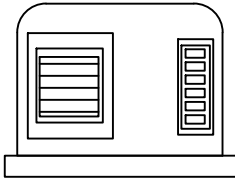

AIR CONDITIONER  
OR HEAT PUMP

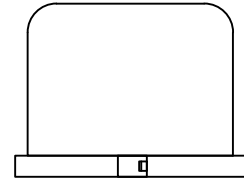

GENERATOR OR  
TRANSFORMER

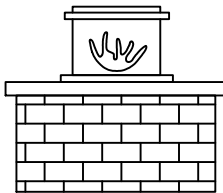

OPEN FLAME OR  
PERMANENT BBQ

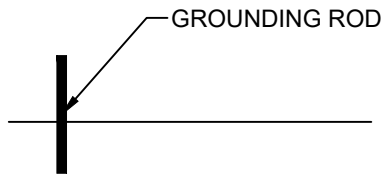

GROUNDING ROD

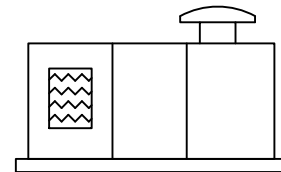

INCINERATOR

REV.	DESCRIPTION	BY	DATE	CHK	APR
REVISIONS					

DRAWN	JNM
CHECKED	CL
APPROVED	CL



UNITIL GAS STANDARDS (NH & MA)  
GAS METER SET ASSEMBLIES  
IGNITION FEATURES

SCALE	DATE	SHEET	DRAWING NO.
N/A	11/03/22	5 OF 6	UAYMX001

# DIAGRAM F

REGULATOR RELIEF VENT  
CLEARANCES FROM FEATURES

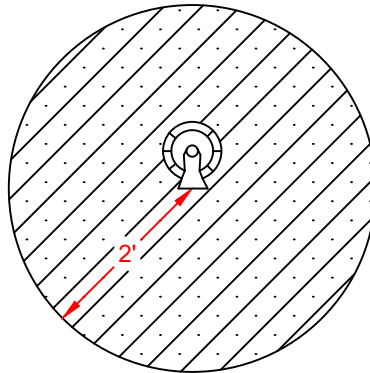

NO FEATURES TO BE PLACED  
WITHIN TOLERANCE ZONE  
(CROSS-HATCHED AREA)

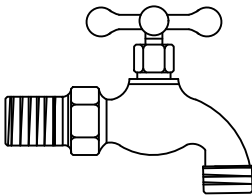

WATER SPIGOT

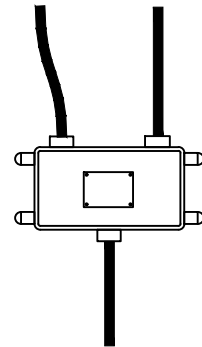

COMMUNICATIONS BOX

						DRAWN		UNITIL GAS STANDARDS (NH & MA)			
						JNM		GAS METER SET ASSEMBLIES			
						CHECKED		OTHER FEATURES			
						CL		SCALE	DATE	SHEET	DRAWING NO.
REV.	DESCRIPTION	BY	DATE	CHK	APR	APPROVED	N/A	11/03/22	6 OF 6	UAYMX001	
REVISIONS						CL					